

YASKAWA

MV1000

MEDIUM VOLTAGE AC DRIVE

175 HP TO 16,000 HP



MV1000

MEDIUM VOLTAGE AC DRIVE

Simple Robust Compact Reliable Safe Feature Packed

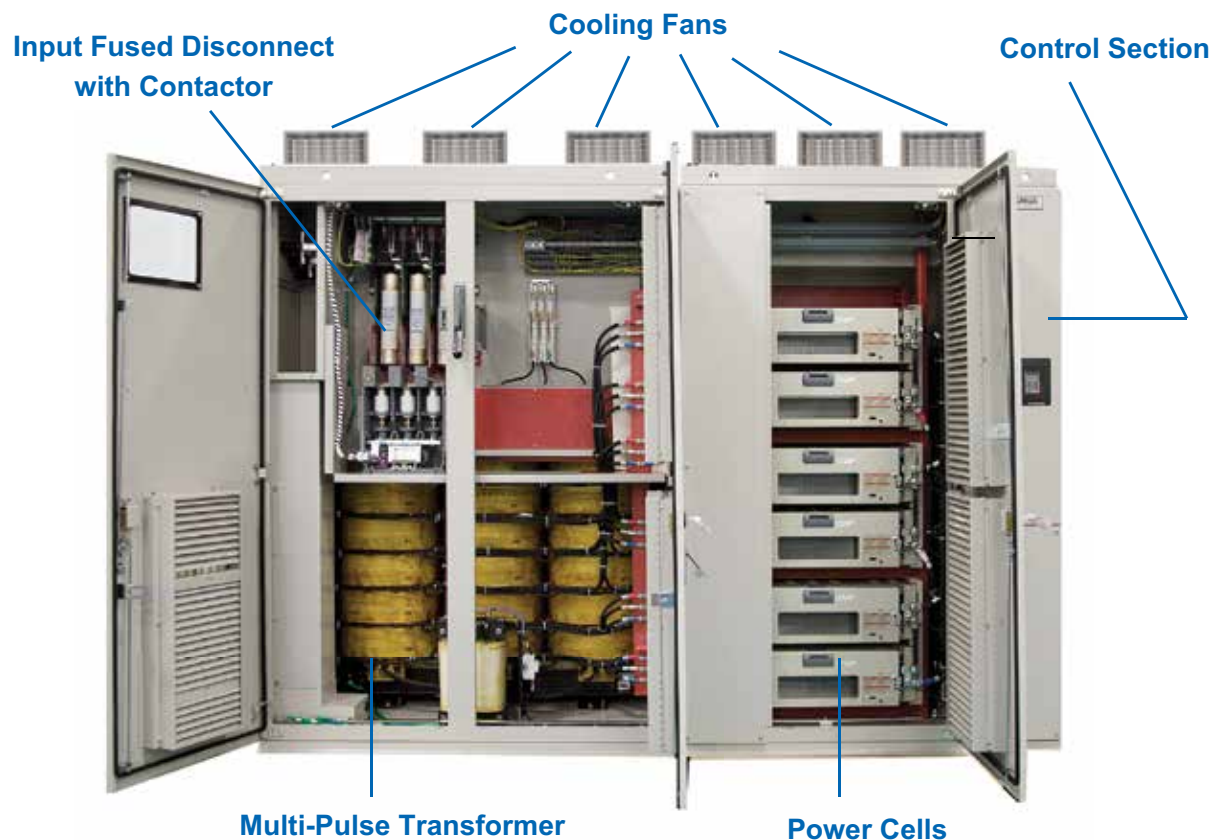

Yaskawa Quality: Second to None

We're the only industrial drives and motion control manufacturer to win the Deming prize – the most prestigious quality award in manufacturing. Yaskawa constantly tracks and measures product failures in time (FIT). The actual FIT data demonstrates a high quality and reliability rate that is the envy of our Industry.

- Internal Assembly Failure Rate 0.01%
- Field Assembly Failure Rate 0.0062%



MV1000 Features and Advantages

Yaskawa Smart Harmonic Technology, Exceeds IEEE-519 Requirements

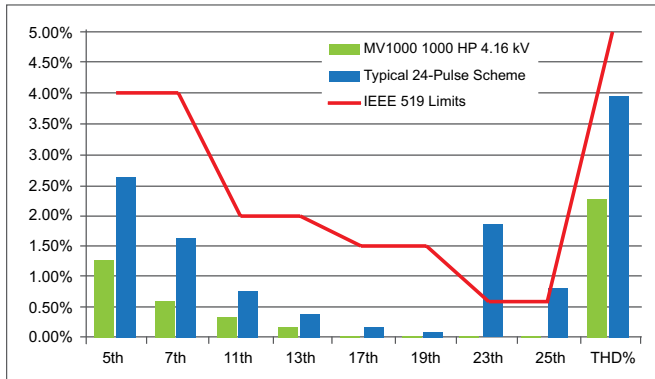

Motor Friendly 17-Level Phase-to-Phase Waveform

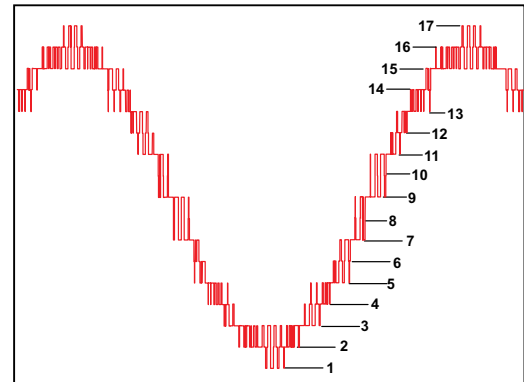

Easy Maintenance with Modular Construction

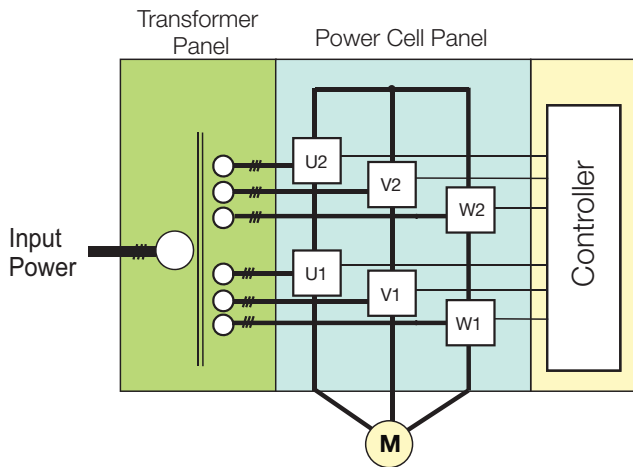

A1000 Drive Based Parameters

- Simple to operate, adjust, and tune
- Remote diagnostics with DriveWizard

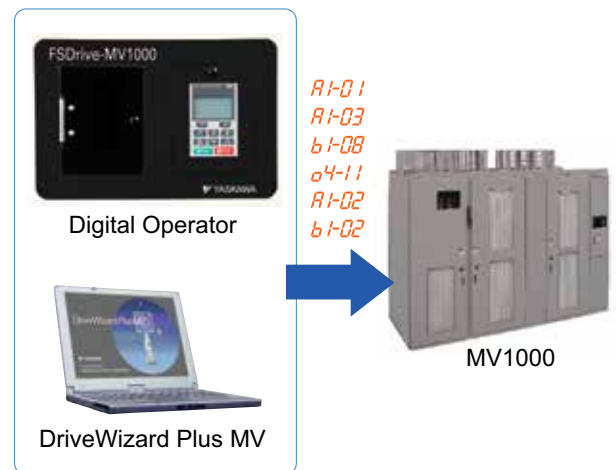

Fiber-Optic Based Controls for High Reliability (MTBF > 200,000 Hrs)



User Friendly Digital Operator

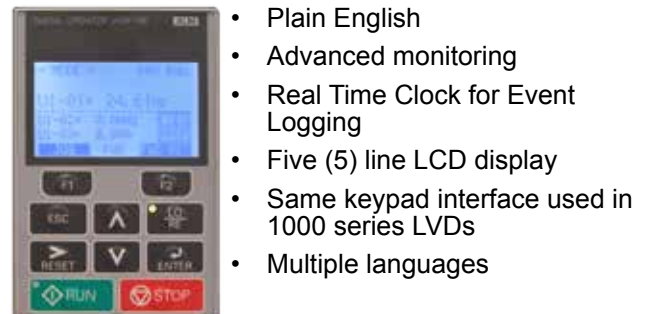

- Plain English
- Advanced monitoring
- Real Time Clock for Event Logging
- Five (5) line LCD display
- Same keypad interface used in 1000 series LVDs
- Multiple languages

Advanced Features

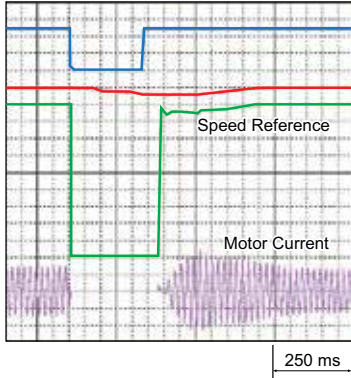

Speed Search Function

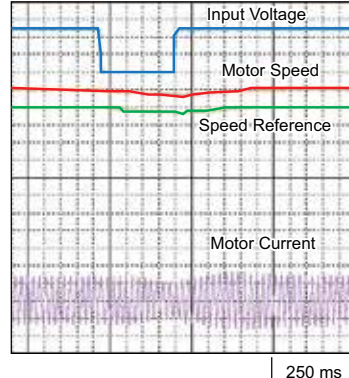

KEB Function

- Power Dip Ride Through
- Kinetic Energy Braking (KEB) Function
- Closed Transition Sync Transfer and Capture
- Speed Search
- Automatic Restart
- Auto Tuning
- Open Loop Vector
- V/Hz Control

Synchronous Transfer from AC Source to Drive

Voltage Waveform Display

- Utility supply voltage (Vrs: 1500V/div.)
- Drive output voltage (Vuv: 1500V/div.)

Utility and drive perfectly synchronized

Current Waveform Display

- Drive output current (100A/div.)
- Utility supply current (100A/div.)
- Motor current (100A/div.)

No disturbance to motor current



Yaskawa Global Support Network



Product Range

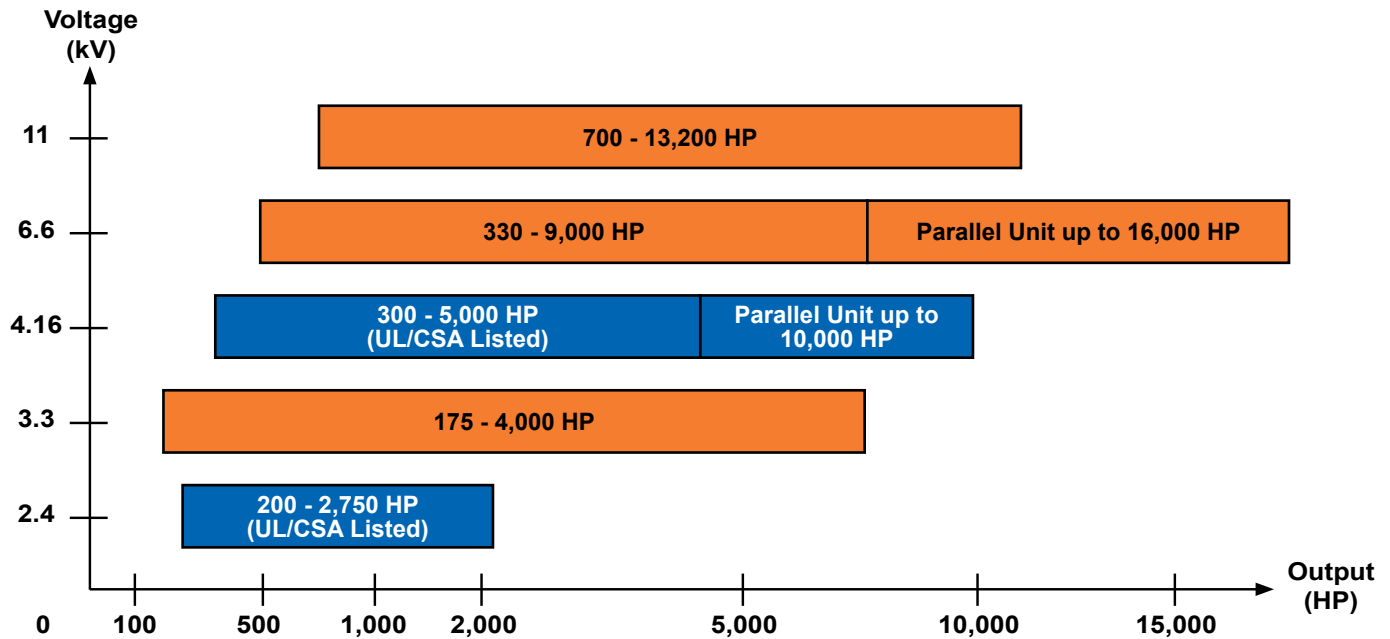

Common Specifications

Item		Specifications
Control Characteristics	Control Methods	V/f Control (V/f), Open Loop Vector Control (OLV), Closed Loop Vector Control (CLV)
	Frequency Control Range	0.01 to 120 Hz
	Frequency Accuracy (Temperature Fluctuation)	Digital input: within $\pm 0.01\%$ of the max output frequency (-10°C to $+40^{\circ}\text{C}$) Analog input: within $\pm 0.5\%$ of the max output frequency (-10°C \pm 40°C)
	Frequency Setting Resolution	Digital inputs: 0.01 Hz Analog inputs: 1/2048 of the maximum output frequency setting (11 bit plus sign)
	Output Frequency Resolution	0.001 Hz
	Frequency Setting Methods	-10 to $+10$ V, 0 to $+10$ V, 4 to 20 mA
	Starting Torque	V/f: 130% at 3 Hz, OLV: 130% at 0.3 Hz, CLV: 130% at 0 r/min
	Speed Control Range	V/f: 1:20, OLV: 1:100, CLV: 1:1000
	Speed Control Accuracy	V/f: ± 2 to 3% , OLV: $\pm 0.5\%$, (25°C $\pm 10^{\circ}\text{C}$), CLV: $\pm 0.02\%$ (25°C $\pm 10^{\circ}\text{C}$)
	Speed Response	OLV: 10 Hz, CLV: 50 Hz
	Accel/Decel Time	0.0 to 6000.0 s (4 selectable combinations of independent acceleration and deceleration settings)
Protection Function	Motor Protection	Electronic thermal overload relay
	Momentary Overcurrent Protection	Drive stops when output current exceeds 132%
	Overload Protection	Drive stops after 60 s at 110% of rated output current
	Overvoltage Protection	Power Cell VPN > 1035 VDC
	Undervoltage Protection	Power Cell VPN < 300 VDC
	Momentary Power Loss Ride-Thru	Resumes operation if power loss is less than 2 s (standard) (UPS Required)
	Overheat Protection	Power Cell = Thermistor, Transformer = PT100 and Thermal Switch
Operating Environment	Ground Fault Protection	Electronic circuit protection
	Ambient Temperature	-5 to $+40^{\circ}\text{C}$ (up to $+50^{\circ}\text{C}$ with output current derate)
	Humidity	95% RH or less (no condensation)
	Storage Temperature	-20 to $+60^{\circ}\text{C}$ (short-term temperature during transportation)
Altitude		Up to 2000 m without derating, up to 4000 m with output current and voltage derating
Communication Protocols (Optional)		EtherNet/IP, DeviceNet, Modbus TCP/IP, Modbus RTU, PROFIBUS DP, and PROFINET



Yaskawa is the leading global manufacturer of low and medium voltage AC inverter drives, AC servo systems, machine controllers, and industrial robots. Our standard products, as well as tailor-made solutions, are well known and have a high reputation for outstanding quality and reliability.

YASKAWA